

Article number: 0110057

Description: Retaining ring JS 40x2
Springsteel

Measures

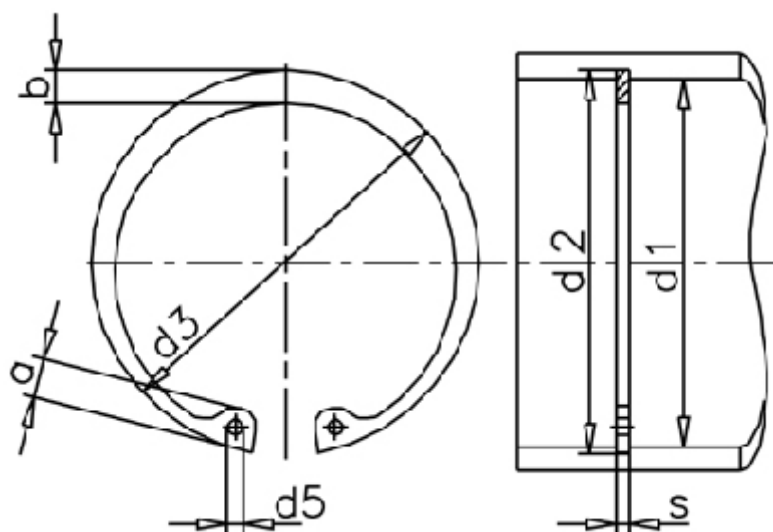

a max	= 6.5	Description	= JS 40	t	= 1.25
AN mm ²	= 162	FN kN	= 27.0	tol	= 0.25
B	= 1.31	FRg kN	= 10.9	tol	= +0,90 -0,39
b	= 3.9	FR kN	= 58.4	tol	= -0.07
d1	= 40	g	= 2.0	Tong	= ZGJ-3
d2	= 42.5	m min	= 2.15	Weight kg/1000	= 5.1
d3	= 43.5	Nominal drive	= 3.8		
d5 min	= 2.5	s	= 2.00		